

# ECLIPSE AIR HEAT BURNERS

Series "AH", "DAH", "TAH" & "CAH"

U.S. Reissue Pat. No. 26,244 Canadian Pat. No. 743,782

*Spec 140*

11/4/03

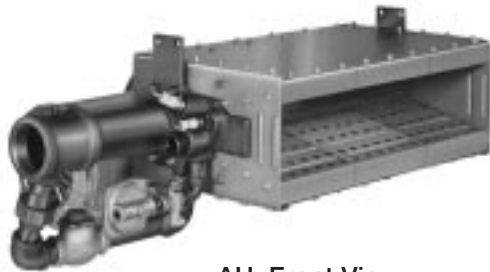

**AH, Front View**  
Data 140-1



**AH, Back View**  
Data 140-1

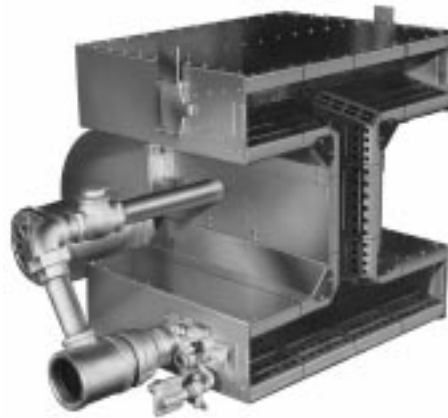

**TAH**  
Data 140-3

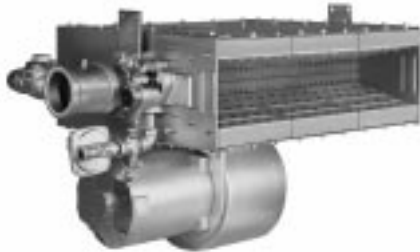

**DAH, Blower Down**  
Data 140-2



**CAH**  
Data 140-4

Eclipse Air Heat Burners are line type burners ideal for generating large volumes of clean, hot air. Applications include ovens, dryers, fume incinerators, and similar industrial equipment.

The "AH" models feature an integral combustion air blower mounted on the back of the burner's steel case. By supplying the correct air volume and pressure to the burner, the blower allows stable operation over a wide range of duct velocities without installing a profile plate around the burner.

- Low NO<sub>x</sub>, CO and aldehydes.
- Exceptional flame stability with duct velocities from 500 to 6000 fpm (2.54 to 30.48 m/s.)
- No profiling required.
- Up to 40:1 gas turndown.
- Inputs up to 1,000,000 Btu/hr. per lineal foot of burner (962 kW/m)
- As little as 10% excess air at high fire; when mounted on the duct wall, no oxygen is required from the process airstream.
- Wide range of configurations, packages, and accessories.



**ECLIPSE COMBUSTION**

## Specifications

<b>Input:</b>	1,000,000 Btu/hr. per lineal foot (962 kW/m).		
<b>Fuels:</b>	Natural gas or 100% propane vapor. Call Eclipse for information on using other fuels.		
<b>Gas Turndown:</b>	40:1		
<b>Pilot Input:</b>	Approximately 25,000 Btu/hr. (7.3 kW)		
<b>Gas Inlet Pressure:</b>	800,000 Btu/hr/ft. (769 kW/m):	Nat. Gas: 2.2" w.c.	5.5 mbar
		Propane: 0.9" w.c.	2.2 mbar
	1,000,000 Btu/hr/ft. (962 kW/m):	Nat. Gas: 3.5" w.c.	8.7 mbar
		Propane: 1.3" w.c.	3.2 mbar
Gas pressure shown is a differential measured between the gas inlet and a tap on the duct wall 10" to 20" (254 to 508 mm) downstream of the burner.			
<b>Ambient Temp. Limits*:</b>	-40° to +104° F	-40° to +40° C	
<b>Downstream Temp. Limits:</b>	1500° F	815° C	
<b>Flame Length**:</b>	800,000 Btu/hr. (769 kW/m):	28"	0.71 m
	1,000,000 Btu/hr. (962 kW/m):	46"	1.17 m
<b>Piloting:</b>	Integral spark-ignited pilot; ignition plug included.		
<b>Flame Monitoring:</b>	<p>Flame rod supplied. UV scanner adaptors are available. For UV scanners, Eclipse recommends a flame monitoring system that terminates the ignition spark and proves the pilot flame without spark prior to opening the main gas valves.</p> <p>Burners over 5 lineal feet include flame supervision at the far end. If pilot ignition is being used, two flame supervision units are required; one for the pilot and one for the far end. If using direct spark on the main flame, only flame supervision at the far end is required providing that ignition can be accomplished within 15 seconds. (Reference NFPA 5-9.2.2)</p> <p>CGA requires two flame rods on burners over 36" long (914 mm). Use a flame monitoring endplate (see Data 140-6) to mount a second flame rod on the end opposite the gas inlet.</p>		
<b>Motor:</b>	Standard: 230/460/3/60 TEFC. Other motors can be supplied.		
<b>Materials:</b>	All portions of the burner exposed to flame are cast iron or #321 stainless steel.		
<b>Emissions</b>	Emissions performance depends not only on the burner, but also other factors such as chamber temperature, chamber design, and heat loading. For estimates of emissions performance in your application, call Eclipse.		
<b>Packaging Options:</b>	Available with complete valve trains and control systems. AH burners and systems can be supplied mounted on duct sections as specified by the customer. Call Eclipse for information on custom packaged systems.		
<b>Models:</b>	<b>Model</b>	<b>Description</b>	<b>Data Sheet</b>
	AH	Line-shape, blower mounted on rear	Data 140-1
	DAH	Line-shape, blower mounted on bottom	Data 140-2
	TAH	"I"-shape, blower mounted on rear	Data 140-3
	CAH	Cross-shape, blower mounted on rear	Data 140-4
<b>Related Information:</b>	Blower and motor specifications		Data 140-5

\* Based on blower motor limitations.

\*\* Based on parallel air flow. If mounted in a cross flow, then flame will be shorter.

**CAUTION:** It is dangerous to use any fuel burning equipment unless it is equipped with suitable flame sensing devices and automatic fuel shut-off valves. Eclipse can supply such equipment or information on alternate sources.

## Mounting Arrangements

### In-Duct

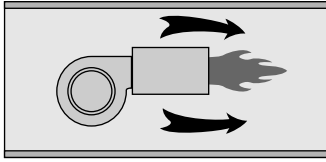

Min./Max. Velocity: 500 to 6000 fpm  
2.54 to 30.48 m/s

Optimum Velocity: 1000 to 4000 fpm  
5.08 to 20.32 m/s

- Provide at least 3" (76 mm) clearance between burner and top, bottom and sides of the duct.
- Profile plates are not required for good burner operation, but uniform velocity must be maintained for full length of burner. If velocity is not uniform, profile plates can be used to correct this condition.

### Sealed

Duct Press: +0.2" to -0.5" w.c.  
+0.5 to -1.2 mbar

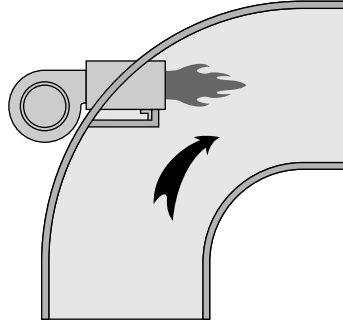

Min./Max. Velocity: 500 to 1200 fpm  
2.54 to 6.10 m/s

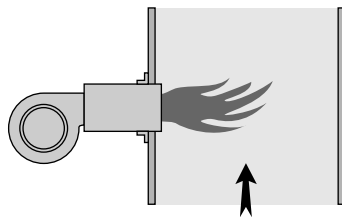

Min./Max. Velocity: 500 to 1200 fpm  
2.54 to 6.10 m/s

### Slot-Fired

Duct Press: 0" to -0.5" w.c.  
0 to -1.2 mbar

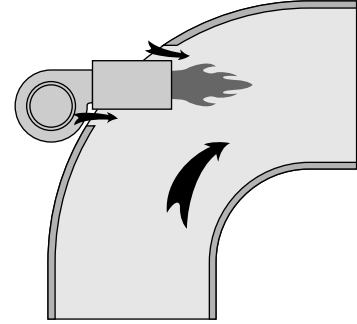

Min./Max. Velocity: 500 to 1200 fpm  
2.54 to 6.10 m/s

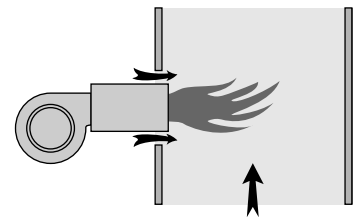

Min./Max. Velocity: 500 to 1200 fpm  
2.54 to 6.10 m/s

### Guidelines for All Mounting Arrangements

- Center the burner in the duct.
- Allow a minimum of 46" (1168 mm) from burner to nearest point of possible flame impingement at an input of 1,000,000 Btu/hr. (962 kW/m).
- On burners longer than 36" (914 mm), use a hanger or a pedestal to support the blower and motor.

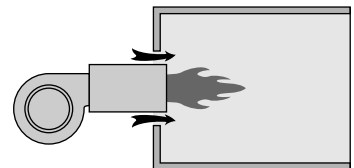

Min./Max. Velocity: 500 to 6000 fpm  
2.54 to 30.48 m/s

Optimum Velocity: 1000 to 4000 fpm  
5.08 to 20.32 m/s

## Burner Firing Arrangements

The AH Burner can fire in any direction. Flow through the burner's check valve, however, must be horizontal. A guide for identifying some standard arrangements is shown below.

**Be sure to indicate the appropriate number arrangement when ordering.** If no arrangement is indicated, No. 1 will be furnished as standard.

### Horizontal Firing

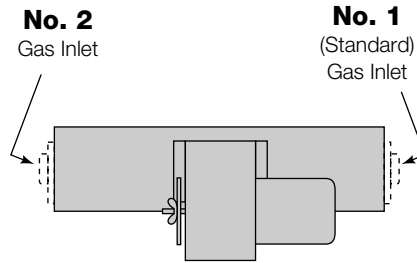

### Vertical Firing Up

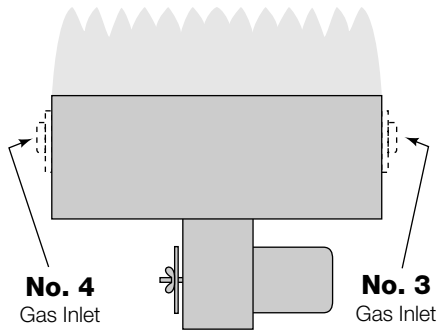

### Vertical Firing Down

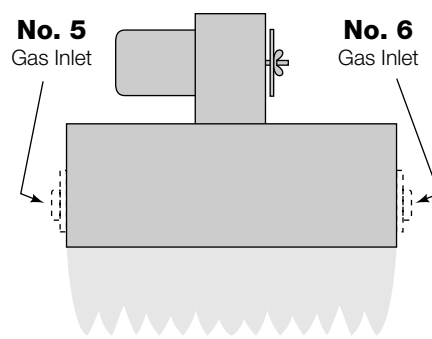

### On End Firing Blower Motor Up

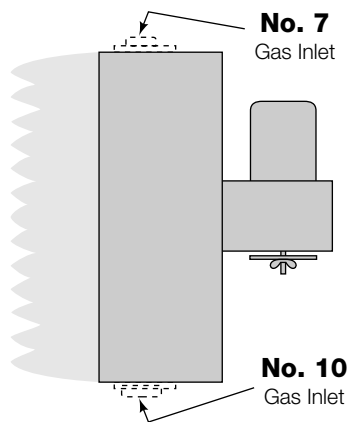

### On End Firing Blower Motor Down

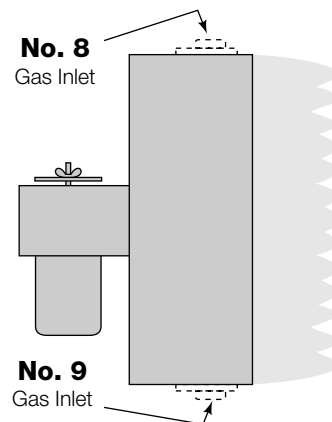

**ECLIPSE COMBUSTION**



**Offered By:**

Power Equipment Company  
2011 Williamsburg Road  
Richmond, Virginia 23231  
Phone (804) 236-3800  
Fax (804) 236-3882

---

[www.peconet.com](http://www.peconet.com)